

AURORA SERIES PORTABLE RADIO

User's Manual



PACKING LIST

- 1 – Radio with Belt Clip
- 1 – Flexible, Helical-Wound Antenna
- 1 – User’s Manual (P/N 7001-30927-401)

CAUTION

Do NOT operate a damaged radio.



TABLE OF CONTENTS

WELCOME	8
INTRODUCTION	9
Optional Accessories	9
External Speaker/Microphone	9
External VOX Headset	9
Battery Packs	9
FCC REQUIREMENTS	10
SAFETY PRECAUTIONS	10
Features	11
Basic and Advanced Model Radios	11
Advanced Model Radios Only	11
Dealer Programmable Options	12

TABLE OF CONTENTS

Before Using Your Radio	13
Battery Installation and Removal	13
Antenna Installation and Removal	14
Radio Views	15
Aurora Radio Controls	16
Front View	16
Display	16
Backlight	17
Keypad	17
Speaker	17
Top View	18
Status Indicator	18
On/Off Volume Knob	18
Squelch Knob	18
Programmable Three-Position Switch	20
Emergency Button	20
Channel Selector Knob	20
Side Views	21
PTT Switch	21
Programmable Softkey Buttons	21
Options Connector	22
Basic Operation	23
Receive	23
TRANSMIT	24
Code Guard Operation	25
Code Guard Receive	25
Code Guard Transmit	26

TABLE OF CONTENTS

Built-in Features	27
Audio	27
Audio Options	28
Battery-Saver Feature	29
VOX Operation	29
Channel Selector	30
HI/LOW Transmit Power	31
Function Menu	32
Mode Selections	32
Backlite	33
Selecting and Activating Frequently Called “Phone List” Numbers	34
Editing Frequently Called Numbers	35
DTMF Encoding	36
ANI Encoding	36
Transmit Time-Out Timer	37
Talk Around	37
Man-Down Switch	37
Emergency Group/Channel	38
Activation	38
Enabling/Disabling	39
Transmit Speed and Frequency	39
Operating Modes	40
Manual Mode	40
Tone/Monitor Toggle	41
Code Guard Mode	42
Variable Guard	43

TABLE OF CONTENTS

Scan Operation	43
Talkback Scan	43
Scan All Groups	44
Change the Scan List	44
Scanning Options	44
Scan Delay	44
Talk Around	45
Scan in Tone Mode	46
Scan in Monitor Mode	46
Transmit on Priority Channel	46
Channel Scan Delete/Add	47
Priority Scan	48
Priority Scan with Code Guard	48
Priority Modes	48
Priority Delay	50
Priority Receiving	50
Priority During Scan-All-Groups Scanning	50
Receive Mode	51
Groups	51
Display Modes	52
Tuning Range	52
Frequency Display Mode	53
Alpha Display Mode	54
Channel Display Mode	55
Radio Paging Code	56
Selective Calling	56
Receiving a Call	56
Sending a Call	57
Radio Check	57
DTMF Dialing	58

TABLE OF CONTENTS

Originating a Call	58
Frequently Called Numbers and Call Paging	59
Radio Paging	61
Flex Mode	61
Keypad and Channel Selector Lock	61
Busy Channel Lockout	62
Battery Power	63
Battery Saver	63
Radio Power-Up	65
Error Messages	65
Stun	65
Aurora Programmed Switch Settings	67
Troubleshooting Guide	69
Maintenance	70
Service	70
Specifications	71
Definitions and Acronyms	73

WELCOME

Statistics show that about 80 percent of you will not look at this manual until after you've already taken the radio out of the box, tried to assemble it, played around with it, and at some point came up with something you didn't understand.

So much
for this
box over
here.

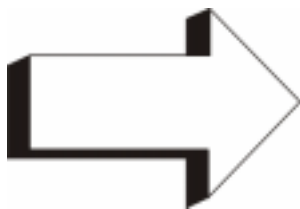

IMPORTANT

To prevent possible damage, read all instructions before operating this radio.

Even if you are reading this before operating your radio, you're still not planning on reading all the instructions before you try to work with your radio, are you?

Well, just be careful because as our warranty states, BK Radio isn't going to cover defects caused by:

- Physical abuse or misuse of the radio
- Neglect or accident
- Improper use or installation of the radio
- Repair or alteration by unauthorized personnel



INTRODUCTION

Congratulations, you now own a BK Radio Aurora Series Flex•Mode™ Radio! This synthesized portable radio uses a microprocessor core to give you features and performance previously unavailable in a hand-held two-way radio. The Aurora radio has been designed to meet the tough requirements of today's communications environment.

The Aurora Series Radios include two models:

- A basic radio model with 1 group of up to 16 channels without keypad or display
- An advanced radio model with 1–15 groups of up to 16 channels each with a keypad and display

These Aurora radios all offer VHF frequency band units.

OPTIONAL ACCESSORIES

External Speaker/Microphone

The Aurora radio has optional external speaker/microphones (LAA0208 and LAA 0222). When the speaker/microphone is installed with the options connector, the internal speaker is defeated.

External VOX Headset

Another option for the Aurora radio is an external VOX headset. When the headset is installed via the options connector, the internal speaker/microphone is defeated.

Battery Packs

The following battery packs are available:

- LAA 0183 NiCd, AA, 1200 mAh
- LAA 0163 NiMH, AA, 1450 mAh
- LAA 0167 NiMH, 4/5A, 1800 mAh
- LAA 0118 Shell for alkaline disposable

Battery Charger

The optional battery charger (LAA 0337) has a dual well. One well is fast-charge, and the other is trickle-charge.

Carry Case

To give your radio more protection, you can order the optional carry case (LAA 0437).

FCC REQUIREMENTS

Your radio must be properly licensed by the Federal Communications Commission prior to use. Your BK Radio dealer can assist you in meeting these requirements. Your dealer will program each radio with your authorized frequencies, signaling codes, etc., and will be there to meet your communications needs as your system expands.

SAFETY PRECAUTIONS



- Do not operate the transmitter in close proximity to blasting caps.
- Do not operate the radio in an explosive atmosphere (petroleum fuels, solvents, dust, etc.) unless your radio is an intrinsically safe model designed for such use.

FEATURES

All Aurora radios have features that are programmed into both the basic and the advanced models, except for scanning features, which are only available in the advanced model.

Below is a list of features that are standard to all Aurora radio models, as well as those features that must be programmed by your dealer.

BASIC AND ADVANCED MODEL RADIOS

- Busy Channel Lockout
- Code Guard™ (CTCSS/CDCSS) on any/all channels
- Transmit Timeout Timer (per channel group)
- Priority Channel Operation
- Hi/Lo Transmit Power
- Soft-key and soft-switch programming
- Emergency switch

ADVANCED MODEL RADIOS ONLY

- Code Guard user reassignment
- Channel, frequency, or alpha user-changeable display modes
- Priority scan
- Multiple scan
- Talkback scan
- DTMF number dialing (keypad)
- Alphanumeric display

Code Guard™ is a trademark of BK Radio.

DEALER PROGRAMMABLE OPTIONS

- Five-tone ANI encode/decode
- Two-tone sequential decode
- Radio Paging: ANI (two-tone, five-tone, DTMF) with frequently called number memory
- VOX (Voice-Operated Transmissions)
- Internal options board activation
- Keyless front panel radio parameter programming
- Man Down (requires optional factory-installed tilt switch)
- Radio stun feature

BEFORE USING YOUR RADIO

BATTERY INSTALLATION AND REMOVAL

Installing the Battery

The battery for the Aurora radio is connected on the back side of the radio. To install the battery, follow the steps below:

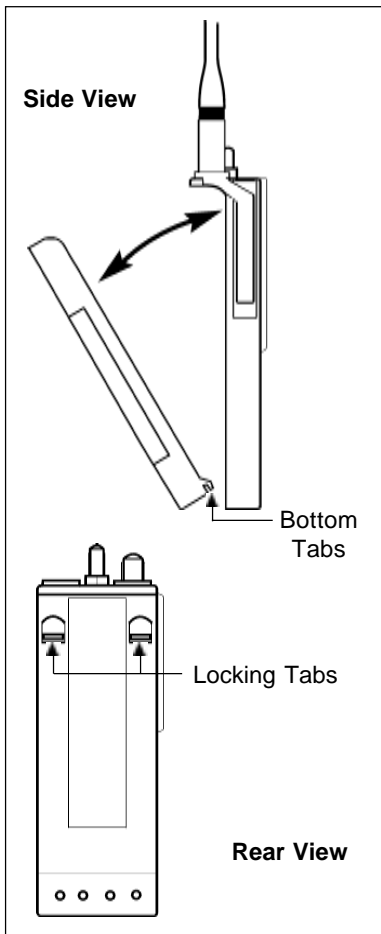

1. With the radio in one hand and the battery in the other hand, face the backside of the radio and the inner side of the battery toward each other.
2. Align the bottom tabs on the battery with the indents on the bottom of the radio and press the radio and battery together at a 45° angle.
3. While keeping the bottom of the battery and radio together, snap the top of the battery to the top of the radio. The locking tabs will hold the battery in place.

Figure 1. Installing and removing the battery

Removing the Battery



WARNING: **Explosion Hazard**

Do not dispose a battery pack into a fire.

To avoid explosion, intrinsically safe radios designed for use in hazardous environments **MUST** use replacement batteries approved by Factory Mutual.

To remove the battery, press down on the locking tabs and reverse the order for installing the battery.

Antenna Installation and Removal

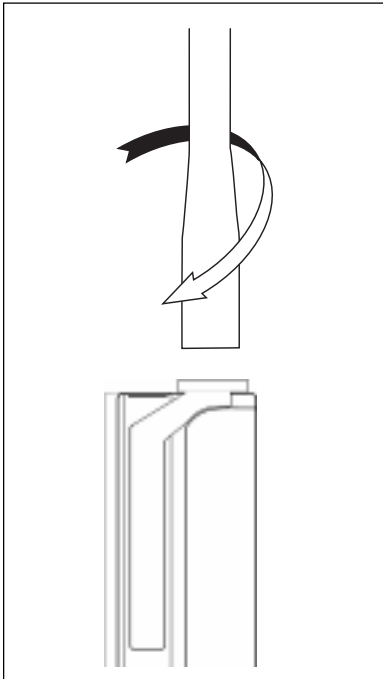

Before using your Aurora radio, you need to install the antenna.

- To install the antenna, carefully place it on the TNC-type antenna connector located on the right side of the radio. Turn the antenna clockwise until it is firmly attached.
- To remove the antenna, turn the antenna counterclockwise until you can lift the antenna away from the radio.

Figure 2. Installing and removing the antenna

RADIO VIEWS

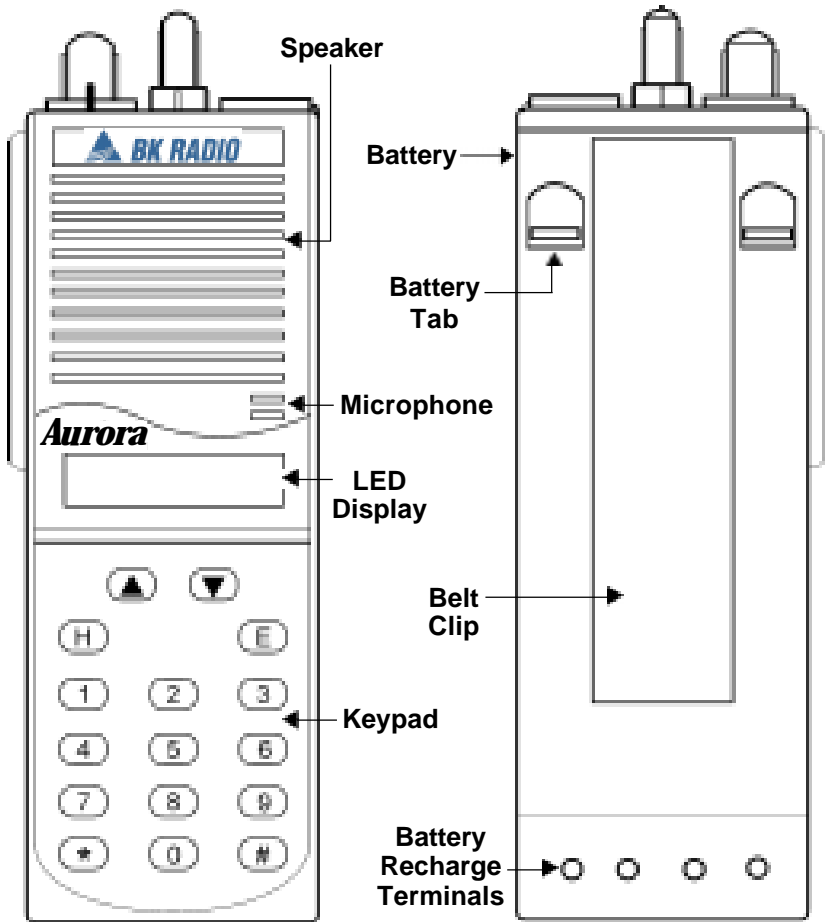

Figure 3. Front and back view











AURORA RADIO CONTROLS

FRONT VIEW

Display

The Aurora advanced model radios have a front panel display that consists of status icons and an alphanumeric display of channel information and radio status. If you select the alpha display mode, the display will show the preprogrammed alphanumeric channel identifier. If you switch to channel or frequency display modes, the LCD displays either the channel number or the channel frequency information. In all cases, the radio status indicators (icons) are shown.

Table 1. Status Icons

Icon	Status
	Low Battery
	Mandown/Emergency
	VOX enabled
	Tone mode activated
	Hi/Lo Transmit Power indication
	Hi power
	Lo power
	Radio Paging Code (audible code) assigned
	Keyboard Locked indicator
	Transmitter Keyed Up (mimics the transmit status indicator except it functions even in military mode)

FRONT VIEW (continued)

Backlight

The Aurora radio display can be backlit, and your dealer programmed one of the following options for your radio:

1. Backlight on whenever you press a key (1–6-second auto timeout)
2. Backlight on whenever a signal is received and the audio is sent to the speaker (1–6-second auto timeout starting at carrier drop)
3. Backlight on whenever you press a key or a signal is received and the audio is sent to the speaker (0–6-second auto timeout starting at key press or carrier drop)
4. No backlight (military/strategic applications). This option also prevents the Transmit/Busy/Low Battery LED to light up.

Note: If *Option 4* of the display backlight LED feature is programmed, the multicolored status LED will not light under any condition.

Keypad

The Aurora radio advanced models have a keypad that contains the keys necessary to access a channel group directly, generate DTMF tones and paging codes, and change operating modes. The keypad is backlit and controlled by the same backlight control as the display.

Speaker

The Aurora radio has an internal speaker so you can listen to the audio received from active carriers on tuned receive-channel frequencies. The internal speaker also lets you hear any audible notifications.

Microphone

The Aurora radio has an internal microphone so you can transmit audio on active carriers with tuned transmit channel frequencies.

TOP VIEW

Status Indicator

A dual color LED indicates the transmit mode, active receive carrier, priority sampling, low battery, cloning, and radio error conditions in the Aurora radio.

Table 2. Status Indicator Colors

Color	Indication
Steady Red	The radio is transmitting
Steady Green	The receive channel is busy (carrier detected) or squelch is open
Flashing Orange	The radio is sampling for the priority channel
10-second Blinking Red	The battery is low
Steady Orange	Radios are transferring data during cloning
5-Second Steady Orange	Error—Number is shown in the display of advanced radios and then the radio is reset

For example, if the radio receive channel is busy and the battery is low, the status indicator will be green with momentary red flashes every 10 seconds.

On/Off Volume Knob

Use the On/Off Volume knob to turn the radio on and off, and control the volume of the unmuted internal and external speaker.

Squelch Knob

The squelch control is used to eliminate speaker noise when a receive signal is not present and no receive Code Guard is being used for the receiving frequency.

TOP VIEW

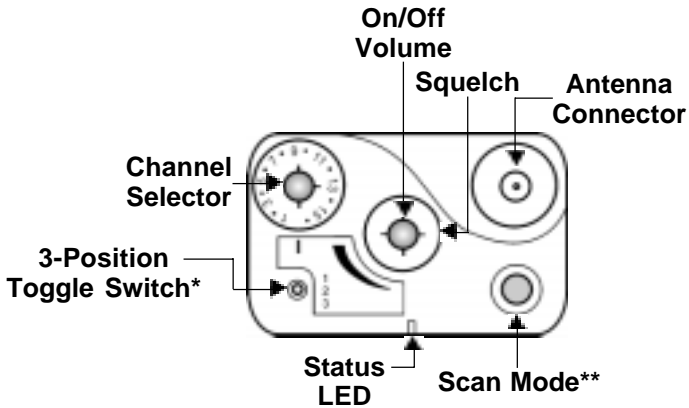

***Three-Position Toggle Switch (Factory Default)**

- 1 Channel frequency
- 2 Channel label
- 3 Group number, channel number, and bandwidth

****Programmable Red Switch**

Factory Default — Scan
Programmable to — Emergency

Figure 4. Top view

Programmable Three-Position Switch

The three-position switch on top of the radio is programmed by the dealer for features you can select in a variety of configurations. The default configuration is shown in Table 3 below:

Table 3. Factory Default for Three-Position Switch

Position	Features
1	Channel frequency
2	Channel label
3	Group number, channel number, and bandwidth mode

Emergency Button

The red button on the top of the radio can be programmed by the dealer as an emergency switch to transmit an emergency ANI sequence when pressed. The factory default for the red button, however, is scan mode.

Channel Selector Knob

The Aurora radio has a channel selector knob on the top of the radio that lets you determine the channel to tune to when receiving and transmitting in manual mode.

General channel parameters include:

- Busy Channel Lockout
- Scan list assignment
- Hi/Lo transmit power specification
- Channel type (voice or data)
- Alpha display information for each channel

Channel parameters of the Aurora radio include:

- Transmit and receive frequencies
- Code Guard assignment, which is received with each frequency
- ANI system and ANI code type
- bandwidth, whether narrow or wide

SIDE VIEWS

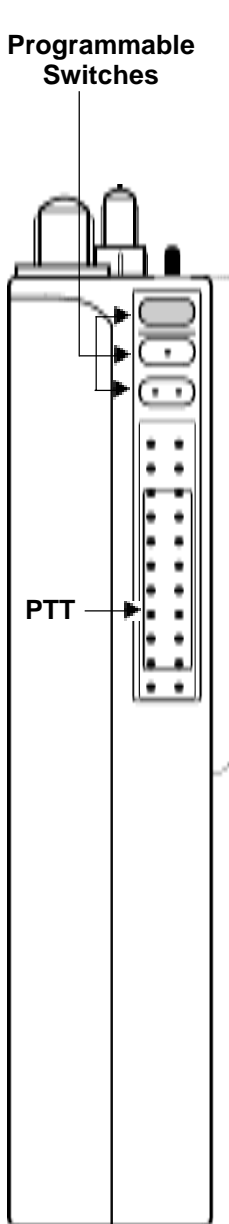

PTT Switch

Use the PTT Switch to key-up the radio's transmitter. At times, activating the PTT switch will not allow transmitter operation, such as when channels have active carriers with busy channel lockout is programmed or if no transmit frequency was programmed for the displayed channel.

Programmable Softkey Buttons

The three softkey buttons on the side of the radio are programmed by your dealer to give you the radio features you want. The default configuration for the three softkey buttons is shown in the table below:

Table 4. Programmable Softkey Buttons

Button	Feature
Top	Toggles Code Guard on and off
Middle	Toggles priority mode on and off
Bottom	Toggles high and low power

Figure 5. Left side view

Options Connector

The Aurora radio has a sealed options connector on the side of the radio (opposite the softkeys and the PTT switch) that facilitates:

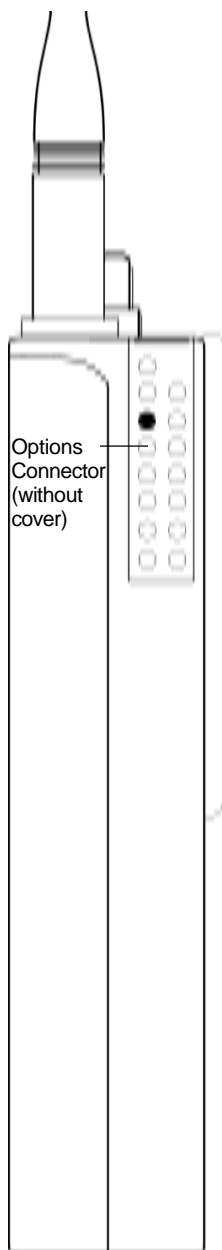

- Programming the radio for dealers
- Using the RF antenna port
- Using external transmit carrier modulation sources
- Outputting data present on receive carriers
- Giving access to external audio, including the microphone and earphone, as well as the necessary control line to switch audio from internal to external sources
- Allowing an external PTT switch
- Allowing an external tone/monitor line
- Using switched battery voltage
- Providing digital and RF grounds
- Inputting data to be transmitted

Figure 6. Right side view

BASIC OPERATION

RECEIVE

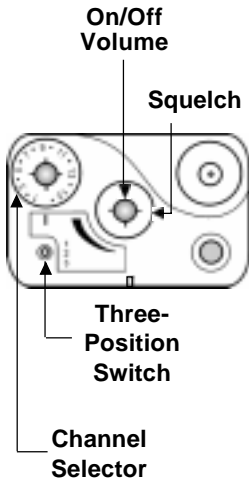

1. Turn power on. Turn the volume knob clockwise. The radio is operational when you hear the beep. The display, if installed, shows the current channel, frequency, or alpha characters depending on the position of the three-position switch on top of the radio. See Table 5.

Table 5. Factory Default for Three-position Switch

Position	Display
1	Channel frequency
2	Channel label
3	Group number, channel number, and bandwidth mode

2. Select a channel. Turn the channel selector knob. Each time you select another channel you will hear a beep.
3. Adjust squelch and volume.
 - a. Turn the squelch knob clockwise until you hear noise.
 - b. Adjust the volume knob until the noise level is comfortable.
 - c. Then turn the squelch knob counterclockwise until the noise stops. This is called the threshold squelch setting.

TRANSMIT

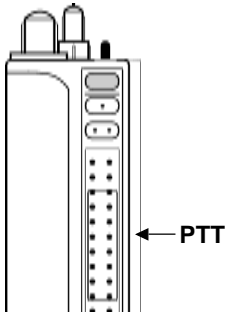

Follow these steps to transmit:

1. Press the PTT switch. When the transmitter is on, the red transmit indicator glows and the transmit icon [] appears in the display.
2. Talk in a normal voice with the microphone 1–2 inches from your mouth.
3. Release the PTT switch to stop transmitting.

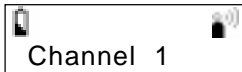
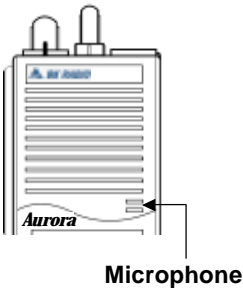

If the transmit status indicator does not glow red when you press the PTT switch, the battery pack may need to be charged. If so, the display will show the low-battery icon [], and the red low-battery status indicator will flash.

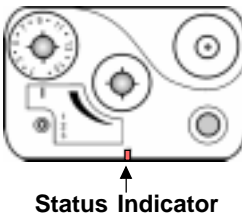

If the transmit status indicator does not glow and you hear a boop (low error tone), you are on a receive-only channel or the channel is busy (if busy channel lockout is enabled). Select an authorized transmit channel.

If you talk longer than the preset timer setting, the transmitter automatically shuts off, and you hear a boop. To continue transmitting, release the PTT switch, press it again, and continue talking.

CODE GUARD OPERATION

Code Guard™ (sometimes called tone code) allows one radio or group of radios to be selectively called within a system. If the radio has been programmed with Code Guard, use the following receive and transmit instructions:

CODE GUARD RECEIVE

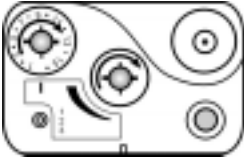

1. Turn power on by turning the volume knob clockwise.
2. Select a Code Guard channel by turning the channel selector knob.
3. Adjust volume (see Receive, step 3, on the previous page).
4. Set Code Guard mode by pushing the soft function button (top gray button is the factory default) that was preprogrammed to toggle Code Guard on or off.

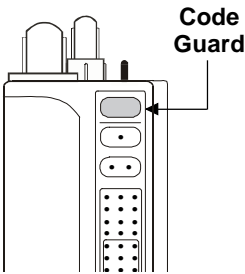

Monitor Mode



Code Guard/
Tone Mode

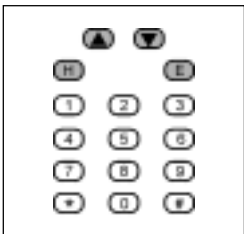

If your dealer reassigned the gray soft function button to a different function, you can also select Code Guard by pushing ▲ or ▼ until Monitor Mode is displayed and then push [E]nter to toggle tone mode [X]. Push [H]ome for normal display.

If your radio is already set to tone mode, the function menu will show Tone Mode instead of Monitor Mode. If you see tone mode in the display, just press [H]ome for normal display.

You will only hear a message if your radio receives the proper Code Guard value.

CODE GUARD TRANSMIT

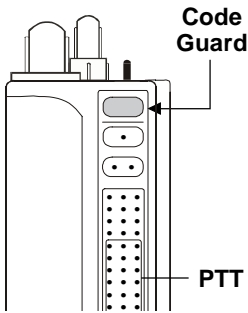

1. Turn on Code Guard mode by pushing the gray button on the side of the radio, which is the factory default for toggling Code Guard on or off. If Code Guard is not assigned to a soft switch, you can also push one of the menu select buttons [▲ or ▼] until Monitor Mode is displayed, and then push [E]nter to toggle tone mode. Push [H]ome for normal display.

2. Listen to the Code Guard channel before transmitting.

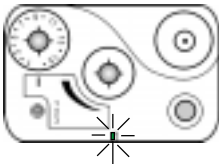

Busy-Channel Status Indicator

Note: Do not transmit if the green busy-channel status indicator is lit.

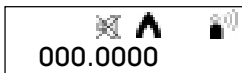

Transmit Code Guard Messages

3. Press the PTT switch. When the transmitter is on, the red transmit status indicator glows and the transmit icon [🔊] appears in the display.

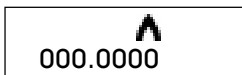

Receive Code Guard Messages

4. To receive only the messages with the proper Code Guard value, press the gray button on the side of the radio. You will see the tone mode icon [🔊] in the display. During extended transmissions, you can leave the squelch open until the exchange has ended.

BUILT-IN FEATURES

The BK Radio Aurora radio is based on a microprocessor core that allows extra features and operational characteristics to be programmed into your radio. Your dealer can help define the best operational settings for your system and program them into the radio.

AUDIO

Beeps, Boops, and Warbles

You can program your Aurora radio through the function menu so that the radio can make five different sounds to notify you of different radio functions:

Beeps

The beep is a tone of 1560 Hz. You will hear the beep:

- When you press a key on the keypad when you are in normal or keypad programming mode
- When you use the channel knob to select a different channel.
- When you press a valid key in the function menu (no beep for invalid key presses)
- When your radio reaches the low battery threshold level number 1. You will hear a single beep every 30 seconds until you turn the radio off.

Boops

The boop is a lower tone of 780 Hz. You will hear a boop when the radio encounters an illegal condition, including the following:

- When you try to transmit on a busy channel that has an incorrect Code Guard tone with the BCL option set
- When you try to transmit on a receive only channel
- When you try to tune a blank (unprogrammed) channel
- When you press an invalid key while in the function menu

Boop-Beep

The boop-beep is a short duration tone of 780 Hz followed by a short duration tone of 1560 Hz. You will hear a boop-beep:

- When you toggle a radio function ON with a softkey or the three-position switch
- When you switch to scanning from manual mode
- When you switch to tone mode from monitor mode

Beep-Boop

The beep-boop sound is a short duration tone of 1560 Hz followed by a short duration tone of 780 Hz. You hear the beep-boop:

- When you toggle a radio function OFF with a softkey or the three-position switch.
- When you switch to manual mode from scanning
- When you switch to monitor mode from tone mode

Warble

The warble sound is a continuous fixed-rate alternating of the beep and boop tones. You hear the warble:

- When the radio receives the notification that the page was received
- When the radio receives a man-down warning

Group pages and all-call pages have the longest alternating rate. The radio page has a noticeably shorter alternating rate, and the man-down notification has a very fast alternating warbling rate.

Audio Options

A dealer can program your Aurora radio for the following options:

- Audible notifications at a fixed volume specified in a percentage between 0% and 100% in 5% increments
- Variable volume setting that follows the volume knob position

BATTERY-SAVER FEATURE

The battery-saver feature can be programmed by your dealer. This function temporarily powers down the hardware when the channel is not busy.

VOX OPERATION

Vox Operation is a special option that can be programmed on or off at the factory. You can use the VOX operation feature with an optional headset that can be connected to the radio via the options connector.

If the your radio has the VOX option, you can either toggle the VOX option ON/OFF with a softkey/three-position switch assigned to the VOX option, or on advanced-model radios, you can use the function menu.

If the options connector from the headset is not attached, you cannot turn on VOX.

If the radio is in VOX mode and the options connector is removed from the radio, the radio automatically turns off VOX mode.

To adjust the VOX trigger sensitivity value:

1. Turn VOX ON by pressing and holding the assigned softkey
2. Continue holding the softkey
3. Speak into the headset microphone at the desired trigger volume level.

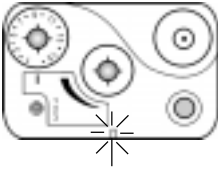

Status Indicator

After 1 second, the radio will automatically start adjusting the VOX trigger sensitivity value. The radio cycles through the 16 available trigger values, starting at the least sensitive value and incrementing to the most sensitive value. Then the cycle wraps around, and the radio repeats the cycle as long as you keep pressing the softkey.

4. When the status indicator LED on the radio turns red, immediately release the VOX softkey. The VOX trigger sensitivity value has been reached.

CHANNEL SELECTOR

Channel Selector Knob

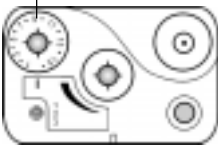

Use the channel selector knob to determine which channel (from 1 to [up to] 16) is tuned for receiving and transmitting when the radio is in manual mode and no priority channel operations are activated. See priority channel operation (page 48) and scanning mode (page 47) for more information about the channel selector knob when these features are activated.

HI/LOW TRANSMIT POWER

Each channel in the radio can be individually programmed to always transmit in low-power or high-power mode, regardless of the position of the radio's switches (or the function menu setting).



Once a radio channel is programmed for low power, you will not be able to change this setting to high power. If a channel has been set to high power at the factory, the dealer can change the power setting to a softkey or the three-position switch. You can also change the power setting from the function menu if not assigned to the three-position switch.

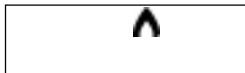

Low Power



High Power

The Aurora radio has a set of display transmit power icons []. One illuminated icon indicates the channel will transmit using low power [], and the other illuminated icon indicates the channel will transmit using high power [].

If the radio is in manual mode, these icons are always illuminated to show either high or low power for the selected channel. If the radio is in scanning mode, the icons only light when a scanned channel has an active carrier that breaks the squelch of your radio. If you select the low-power setting, the low-power icon will be the only transmit-power icon lit, regardless of the transmit power programmed for that channel.

FUNCTION MENU

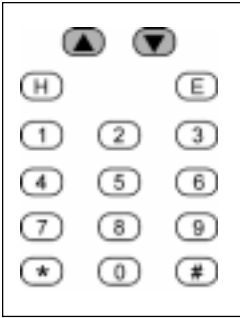

Any functions not assigned to a side button or the three-position toggle switch can be enabled/disabled with ▲ or ▼ on the keypad.

You can use the function menu as follows:

1. Press ▲ or ▼ to display the function menu.
2. Use the ▲ or ▼ keys to move from one function to the next forward or backward. You will hear a beep with each key press. If you press an invalid key, however, you will hear a boop.

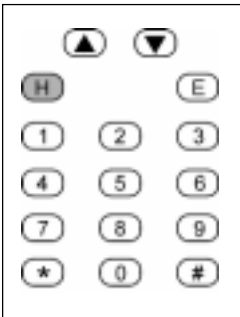

3. Press [H]ome to exit the function menu.

If the function menu is on Radio Page, press [H]ome twice slowly to exit.

4. Press [H]ome twice to quickly clear the radio page number. The radio then waits for you to enter the new number.

Note: Any functions assigned to the three-position switch or the three buttons on the side of the radio, that function is not displayed in the function menu.

Mode Selections

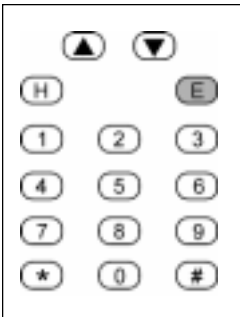

Press [E]nter to toggle the following factory-default mode selections:

- Call DTMF/5 Tone
- Monitor/Tone
- Back Light
- Priority
- Talk Back
- Talk Around
- Manual/Scan
- Scan All
- Key Beep
- Power Hi/Low
- Programming (for dealers only)
- Frequently called number list

You can change the attributes of the following functions by pressing keys as described below:

Backlite

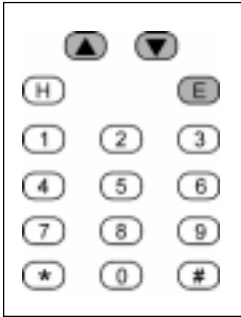

1. Press [E]nter to start the timeout value to flash.
2. Press [E]nter. The existing number will flash.
3. Press [0]–[6] to set the time to off (0) or for 1-6 seconds.
4. Press ▲ or ▼ to change the timeout value by 0.1 second.
5. Press the [E]nter key to exit the backlite editing mode. Press [H]ome to exit function menu.

Priority Channel

You can only select priority channel mode when the radio is in Mode C or D.

Press the [E]nter key to make the value change to the channel knob assignment.

Radio Page

This function displays the page type (DTMF or 5 Tone) and then displays the last-called number, if any. (These numbers can only call other radios. Don't give your cell phone away.)



1. Press any key [0]–[9] to clear the display.

The key you just pressed and subsequent keys are displayed, up to 10 digits.

2. Press PTT when a radio page number has been entered. After the page has been sent, the radio exits the function menu.

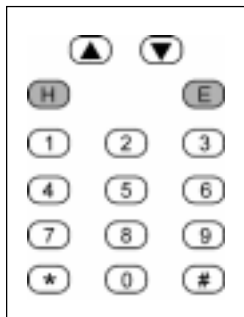

3. Press the **[H]**ome key twice quickly to delete the number from the list.

4. Press the **[H]**ome key twice slowly to exit the function menu.

Each time you press **[E]**nter, the number type is toggled between DTMF and 5 Tone. The radio then displays the current frequently called number.

Selecting and Activating Frequently Called “Phone List” Numbers

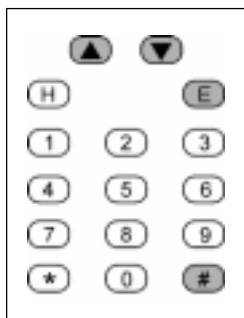

1. To see your list of frequently called phone list numbers, press **[E]**nter when the list is displayed to choose a frequently called number. Press **[0]–[9]**, or press **▲** or **▼**.

2. Press **[#]** while scrolling the frequently called numbers list to sequentially display one of the three attributes of the current frequently called number:

- type (DTMF or 5 Tone)
- alpha (Name for frequently called number)
- number (frequently called number, shortcut to number in list)

3. Press the PTT switch while the radio transmits the selected DTMF page, and then exit the function menu.

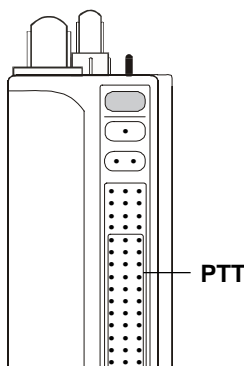

Editing Frequently Called Numbers

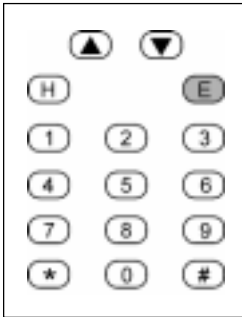

To edit a frequently called number, press **[E]**nter when the display shows the attribute for the currently selected number.

You can use the following valid keys to edit a frequently called number attribute:

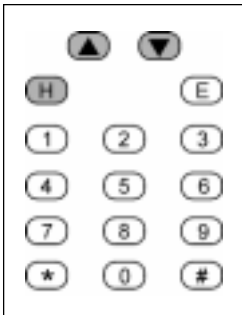

- **[H]**ome. Clears the number or alpha. Type attribute has no effect.
- **▼**. In edit mode, the down arrow key shifts the cursor to the right.
- **▲**. In edit mode, the up arrow key shifts the cursor to the left.
- Any key. When you press any key more than once, the radio will display the character set for that key based on the number or alpha attribute you selected.

Pressing the same key more than once also lets you move the cursor when you are editing a number and/or alpha character.

DTMF ENCODING

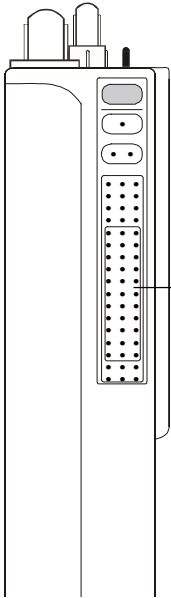

Keypad-equipped radios can be programmed to enable DTMF (Dual Tone Multiple Frequency) number dialing sequences.

To send DTMF tones:

1. Press [H]ome to return to the main display if your radio is in the DTMF function menu.
2. Press and hold the PTT switch.
3. Press any key on the keypad (except arrow keys).

You will hear a sidetone (sounds like the tones you hear when dialing a telephone). The frequently called number list can be used for storage of DTMF transmit sequences.

Use the frequently called number list to store your DTMF transmit sequences.

Note: If you are still in the DTMF function menu, press [H]ome to leave the function menu.

ANI ENCODING

ANI encoding (Automatic Number Identification), if enabled, transmits a sequence of 5-tone or DTMF tones each time you press PTT. You will hear a sidetone. Your dealer can program an ANI number for your radio.

TRANSMIT TIME-OUT TIMER

The transmit timeout timer is dealer-programmable. The length of the time out is the maximum amount of time the radio transmits after you press the PTT button. If you are still talking past the timeout timer, the radio will stop transmitting and you will hear a continuous beep error message until you stop pressing PTT. Your dealer can program a group's transmit timeout timer from 0 [no time out] to 4 minutes in 15-second increments.

TALK AROUND

When you select Talk Around, your radio will transmit on the frequency of the channel you just received, and use the receive Code Guard and bandwidth parameters of that channel.

You can activate the talk-around feature from the function menu if the function was not assigned to the three-position switch.

If talk around is enabled, Code Guard and paging ANIs are both temporarily removed from the channel. When this happens, you cannot see the radio paging icon [] in the display of your radio.

MAN-DOWN SWITCH

The man-down feature is a factory-installed option. The switch is activated when the radio is tilted. Then the radio will start an emergency ANI sequence transmission indicating the user is “down.”

EMERGENCY GROUP/CHANNEL

The emergency sequence is always transmitted on the emergency group/channel regardless of the current function mode and channel. Once the emergency sequence is started, and up to the time it is acknowledged, the radio will stay on the emergency group channel, although the channel knob and group change function are still active.

If you take the radio off the emergency group/channel during an emergency sequence, within the next 15-second transmission interval, the radio will return to the designated emergency group/channel.

Activation

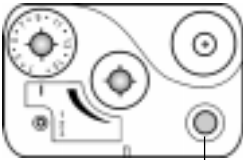

Emergency Button

To activate the emergency ANI sequence transmission:

- Press and hold the emergency button. Your dealer can program the emergency activation from 0.5 to 4.0 seconds in 0.5-second intervals, or
- Tip the radio sideways. The factory installed internal man-down tilt switch will activate the signal.

Once activated, the man-down/emergency icon [] appears in the display in advanced models. Your dealer can program the length of time the radio can be tilted before the man-down/emergency code is transmitted.



Man-down/
Emergency Icon

Three seconds before starting the man-down emergency sequence, you will hear the man-down audible warning (a fast-rate warbling lasting 3 seconds). If you put the radio upright during the man-down audible warning, the radio stops the emergency sequence. If the radio stays tilted for the duration of the man-down audible warning, the emergency sequence is immediately activated.

Enabling/Disabling

You can enable or disable the man-down emergency mode either with the softkey/ three-position switch assigned to the man-down function or with the function menu. As long as the man-down switch is factory installed, even if your dealer didn't program the emergency button to be used for the emergency feature, the man-down emergency feature remains available.

Transmit Speed and Frequency

The emergency feature, when activated, transmits the radio's emergency ANI up to five times at 15-second intervals until the radio emergency is acknowledged by the dispatcher (by sending the radio's ANI).

If the radio does not receive an emergency acknowledgment, the emergency ANI sequence is transmitted up to another five times at 15-second intervals, except this time the radio waits for an inactive emergency channel condition before transmitting.

OPERATING MODES

MANUAL MODE

Channel
Selector
Knob

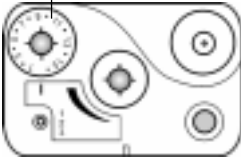

The Aurora radio can operate in manual mode, which ties the receive and transmit frequencies to the channel you select with the channel selection knob (within the currently selected channel group).

For advanced model radios, you can select manual mode from the function menu if manual/scan or talk around is not assigned to the three-position switch.

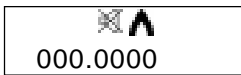

For advanced radios in tone mode [], your radio displays the receive and transmit frequencies that indicate the reassigned Code Guard. You can see the number of the reassigned channel in the right-most part of the radio display.

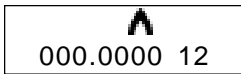

Reassigned
↑
channel number

Receive and transmit frequencies also indicate the assigned radio paging code (audible signals) by lighting the paging icon [] in the display when the radio is tuned to that frequency.

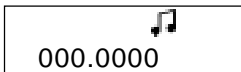

When the radio is in monitor mode, the paging code icon is not lit.

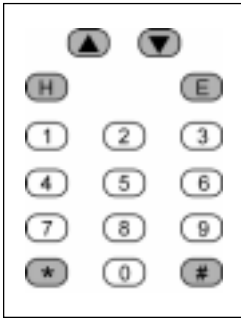

For advanced radios in manual mode, you can use the keypad for the following six functions:

- 1 Reassign the variable guard.
Press number keys [0] through [9]
- 2 Enter group change mode:
Press the [H]ome key. Then press ▲ or ▼ to change the group number.
- 3 Add or delete channels from the scan list.
Press the [E]nter key.
- 4 Review a channel's Code Guard assignment.
Press and hold the [*] key.
- 5 Enter the function menu.
Press either ▲ or ▼.
- 6 Lock or unlock the keypad.
Press and hold the [#] key for 1 second.

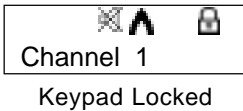
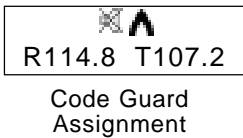

If priority channel operation is activated in manual mode, the radio will monitor, not only the selected manual channel, but also the group priority channel at the priority sampling rate.

Tone/Monitor Toggle

From the function menu, you can toggle tone mode and monitor mode:

- 1 Tone mode—Listening to channels only if the correct Code Guard or radio paging code programmed for that channel is present.
- 2 Monitor mode—Listening to channels regardless of the channel Code Guard or radio paging code programming.

Channels assigned with receive selective calling signals and set for busy-channel lockout cannot be monitored if the radio is in monitor mode.

Channels that are programmed with no tone are not affected if the radio is placed in either monitor mode or tone mode.

You will hear a beep/boop sound when toggling between tone and monitor modes. For advanced model radios, the tone mode icon [] is illuminated when you put the radio in tone mode, and turned off when you put the radio in monitor mode.

CODE GUARD MODE

The Aurora radio is capable of encoding or decoding any of the currently used 50 CTCSS tone guard signals, as well as any custom tone from 67.0 Hz to 254.1 Hz within 1% tolerance, or any of the 104 CDCSS Code Guard signals. The radio is capable of encoding one tone/code and decoding a different tone/code on the same channel.

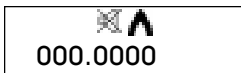

Code Guard

Code Guard is active only when the radio is in tone mode. While the radio is in tone mode and the receive channels are programmed with Code Guard, you can hear the message when tuned to and receiving a frequency that has the same Code Guard.

If the receive channel frequency is present, but Code Guard is either not present or incorrect, your radio stays quiet while receiving that signal, even though the status LED is illuminated to show channel activity.

Variable Guard

Advanced model radios have a variable guard feature that lets you reassign the Code Guard of one channel to another channel within a group. You can use this feature if your dealer programs your radio to let you:

- Use the variable guard reassignment per group option.
- Decide if you want the Code Guard reassignment to apply to both the receive and transmit channel frequencies or to just the transmit frequency.

SCAN OPERATION

Scan mode applies to a single channel group for a maximum of 16 channels in a scan list. You can switch from manual to scan mode from the function menu if manual/scan or talk around is not already assigned to the three-position switch.

Scan All Groups

Advanced Aurora radios also offer a scan-all-groups option that scans through the channels in all groups consecutively. You can select this feature from the function menu if scan all is not assigned to the three-position switch.

When you are scanning with both scan all and priority enabled, the priority channel you are sampling or transmitting on will occur within the group that the radio was in when you started the scan-all-groups scanning.

When you change the radio from manual to scan mode with scan all enabled and then later you switch back from scan to manual mode, the radio returns back to the group it was in when you started scan mode.

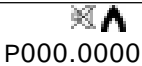

P000.0000

Change the Scan List

Your dealer can program your radio to give you the option of changing the scan list channels yourself.

Scanning Options

Advanced Aurora radio models offer several scanning options:

Scan Delay

The Aurora radio has a scan-delay time parameter from 0 to 5 seconds in 0.5-second increments. Your dealer can program this time parameter on a per radio basis.

The scan-delay time starts when the person you are listening to stops talking. The length of time your radio stays on that scanned channel gives you time to transmit or continue receiving on that channel before the radio starts scanning again.

After the scan delay time, if the radio is not in priority channel operation, the radio transmits on the channel indicated by the channel selector knob within the group that is being scanned (see priority channel operation for radio scanning operation while priority mode is enabled on page 48).

Talkback Scan

Your radio has a talkback feature (sometimes called talk around) that lets you transmit on the channel you just received a signal on under the following conditions:

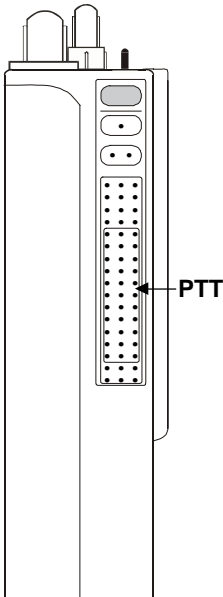

1. You stay on the same channel
2. You keep the radio in scan mode
3. You press the PTT switch while you are receiving the channel or during the scan-delay period

You can activate talk around with a computer-assigned softkey/three-position switch or from the function menu if talk around is not assigned to the three-position switch.

If talkback scan is assigned to the three-position switch, the manual/scan feature is automatically added. Then with the three-position switch, you can select one of the following options:

- Perform in manual mode
- Perform in scan mode with talkback on
- Perform in scan mode with talkback off (see priority channel operation for talkback scan operation while priority mode is enabled).

Scan in Tone Mode

The Aurora radio is capable of scanning and receiving channels with CTCSS tone guards or CDCSS Code Guards. When you are on a scanned channel with a carrier present, the radio will try to decode the proper tone. If it does, you will hear the message.

If the channel has a carrier present, but the tone is incorrect, the radio skips that channel (removes it from the scan list) for a period of 3 seconds, and then adds it back to the scan list.



Channels with radio paging codes assigned to the receive frequency of the channel cannot be part of a group's scan list.

Scan in Monitor Mode

If you are listening to a signal on a scanned channel, the radio will stay on that channel as long as your radio keeps receiving the signal. It does not matter if the channel has a Code Guard or a radio paging code assigned to it unless busy channel lockout is set for that particular channel.

Transmit on Priority Channel

The Aurora radio has a feature that lets you transmit on the priority channel while in scan mode (see priority channel operation on page 48).

Channel Scan Delete/Add

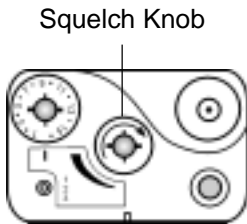

With the Aurora radio, you can delete and add channels to the scan list in each group if this feature is programmed in your radio.

To add or delete a channel from the scan list:

1. Use the function menu to put the radio in scan mode on an active receive carrier.
2. Tune your radio to the frequency of a receive channel frequency, or open the squelch to the channel being added or deleted.
3. Press **[E]nter** to toggle between deleting or adding a channel to the scan list.

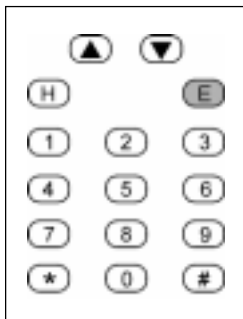

If the channel is already in the scan list, pressing **[E]nter** will delete it from the scan list, and if the channel is not on the scan list, pressing **[E]nter** will add the channel to the scan list.

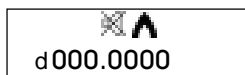

Channel
deleted from
scan list

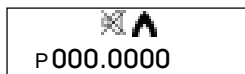

Priority channel
deleted from
scan list

When the radio is on a channel in manual mode (or scan mode on an active channel) and you have deleted the channel from the scan list, the display will indicate that this channel is not on the scan list by displaying “d” in the first alpha character position of the display. If the channel is the group’s priority channel, then a “p” is shown instead of “d” for a deleted channel.

Priority Scan

Priority Scan with Code Guard

Priority scan can be used along with Code Guard when:

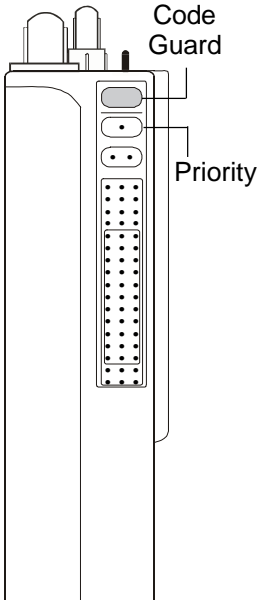

- You move the three-position switch into position 1, which displays the channel frequency.
- You press the top, gray button on the side of the radio to toggle to the Code Guard position
- You press the middle button on the side of the radio to toggle to the priority position
- The priority channel is programmed with Code Guard

If a message is received on the priority channel, the radio receiver locks on to the priority channel for the duration of the signal. You will only hear the message if the proper Code Guard value is received. The radio resumes scanning after the message ends and the scan delay time expires.

PRIORITY MODES

The Aurora radio has five priority channel modes of operation as shown in Table 6.

Your dealer can program these modes by group, which lets the radio receive on any channel while monitoring for messages on the designated priority channel. The priority sampling rate can be programmed by your dealer for between 0.25 and 2.50 seconds, regardless of activity on any other channel.

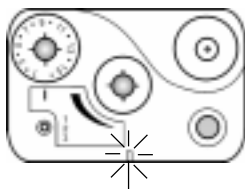

Orange Status Indicator

When you turn on priority mode by pressing the middle button on the side of the radio, you will see the status indicator flash orange, which indicates an actual priority channel sampling.

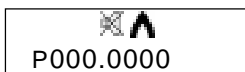

Priority Channel

For advanced model radios, the priority channel of a group is indicated by a “P” [a small “p” when deleted from the scan list] on the left side of the radio display.

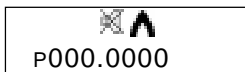

Priority Channel deleted from scan list

Table 6. Priority Modes

	Mode A	Mode B	Mode C	Mode D	Mode E
Receive Manual	Channel Knob	Channel Knob & Samples Preset Priority Channel	Channel Knob & Samples Preset Priority Channel	Channel Knob & Samples User Selected Priority Channel	Channel Knob & Samples User Selected Priority Channel
Receive Scan	Scan List & Samples Channel Knob	Scan List & Samples Preset Priority Channel	Scan List & Samples Preset Priority Channel	Scan List & Samples User Selected Priority Channel	Scan List & Samples User Selected Priority Channel
Transmit Manual	Channel Knob	Channel Knob	Preset Priority Channel	Channel Knob	User Selected Priority Channel
Transmit Scan	Channel Knob	Channel Knob	Preset Priority Channel	Channel Knob	User Selected Priority Channel
Transmit Scan w/Talkback On					
with carrier	Last Received Channel	Last Received Channel	Last Received Channel	Last Received Channel	Last Received Channel
with no carrier in scan delay time	Last Received Channel	Last Received Channel	Last Received Channel	Last Received Channel	Last Received Channel
with no carrier out of scan delay time	Channel Knob	Channel Knob	Preset Priority Channel	Channel Knob	User Selected Priority Channel

Modes B and C--Fixed Priority

Modes D and E--Selectable Priority

Priority Delay

Your dealer can set the priority delay time for 0 to 5 seconds in 0.5-second increments. This time delay is the time from when you lose a carrier for the priority channel and the time the radio stays tuned to the receive frequency of the priority channel. This is also the time you have to transmit on the transmit frequency of the priority channel.

Priority Receiving

Priority channel receive sampling only occurs while the radio is not transmitting. With priority mode enabled, the radio samples either the programmed preset priority channel (modes B or C), the priority channel that you selected (modes D or E), or the position of the channel knob (mode A) (See Table 6).

Priority During Scan-All-Groups Scanning

The priority channel that is sampled and all priority mode transmitting occurs within the group the radio was in when Scan All Groups scanning was initiated.

Table 6 summarizes channel selection, whether scanning is in manual mode, whether the talkback scan feature is enabled, and whether a carrier is present at the time you press the PTT switch. This information is only for channel selection. Other settings, such as busy-channel lockout during active carriers, will still determine whether actual transmission is possible.

RECEIVE MODE

Groups

A channel group can have up to 16 tunable channels (both receive and transmit frequencies). The basic Aurora radio has one group, and the advanced Aurora (with keyboard and display) has from 1 to 15 groups, depending on the computer programming. Although the maximum allowable channels per group is 16, any number less than that, down to one channel, can be programmable in a group.

For advanced model radios, you enter group-change mode by following these three steps:

1. Put the radio into receive mode by not transmitting.
2. Press the **[H]**ome key while in receive mode. The display will show "Group XX" where XX is the current channel group.

Group 12

Channel Group 12

Note: If the radio is scanning when you enter group-change mode, the radio will be temporarily disabled until you exit group-change mode.

3. Once the radio is in group change mode, the only active front keypad keys are:

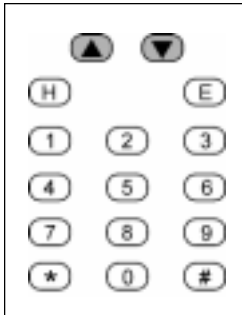

- **[▲]** Changes the radio to the next highest group, or if the radio is already at the highest group, it wraps around to Group 1
- **[▼]** Changes the radio to the next lowest group, or if the radio is already at group 1, the group wraps around to the highest channel group

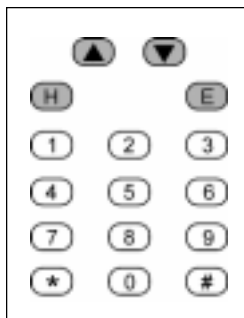

- **[E]nter** Exits the group change mode
- **[H]ome** Displays the alpha label of the group

The radio will remain in group change mode until you exit by pressing the **[E]nter** key.

DISPLAY MODES

You can select a display mode either with a softkey/three-position switch programmed to display functions, or with the function menu.

If you use a softkey, each key you press selects the next display mode. The radio will keep cycling through the channel, frequency, and alpha modes.

If you use the three-position switch (factory default),

- Position 1 is channel frequency
- Position 2 is channel label
- Position 3 is group number, channel number, and bandwidth mode

TUNING RANGE

The tuning range of Aurora's basic and advanced radios cover the VHF band from 136.0000 MHz to 174.0000 MHz.

FREQUENCY DISPLAY MODE

If you own an Aurora radio with a display, you have the option of displaying the current group/channel frequency information as follows:

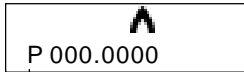

P 000.0000

↑
Priority Channel

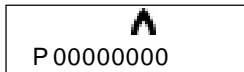

P 00000000

Character
Positions 2–9



P 00

Character
Positions 13–14

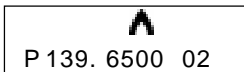

P 139. 6500 02

- Priority channel/deleted channel specifier (first display character position)

P = Group priority channel
Select in scanlist

p = Group priority channel
Delete from scanlist

“ ” = Not group priority channel
Select in scanlist

d = Not group priority channel
Delete from scanlist

- Current Group/Channel frequency in megahertz

P00000000 = character positions 2–9

PG01 CH01 = group/channel

- Variable Code Guard reassignment

ZZ = [display character positions 13–14]

ZZ = reassigned Code Guard channel
1–16

For example, a radio is in group 8 and tuned to channel 12 at a frequency of 139.6500 MHz. Channel 12 is the priority channel for group 8 and currently in the scan list. You reassign the Code Guard of channel 12 to the Code Guard of channel 2 by pressing the channel numbers on the keypad. The display of the radio will then look like the display to the left.

ALPHA DISPLAY MODE

If you have an Aurora radio with a display, you can select how the radio shows you the current group/channel alphanumeric information:

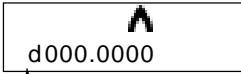

Deleted Channel



Character
Positions 2–11



Character
Positions 13–14

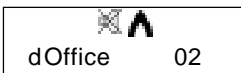

- Priority channel/deleted channel specifier (first display character position)
 - P** = Group priority channel
Select in scanlist
 - p** = Group priority channel
Delete from scanlist
 - “ ” = Not group priority channel
Select in scanlist
 - d** = Not group priority channel
Delete from scanlist
- Current Group/Channel alphanumeric
 - YYYYYYYYYY** = display character position 2–11
 - YYYYYYYYYY** = group/channel alphanumeric, up to 10 characters
- Variable Guard reassignment
 - ZZ** = display character position 13–14
 - ZZ** = reassigned Code Guard channel, between 1 and 16

For example, the display to the left shows a radio in group 8 and tuned to channel 12 whose channel label is Office. Channel 12 is not the priority channel of the group and has been deleted from the scan list. You reassign the Code Guard of channel 12 to the Code Guard assigned to channel 2. The display will then look like the bottom display to the left.

CHANNEL DISPLAY MODE

If you have an Aurora radio with a display, you can select how the radio displays the current channel information:

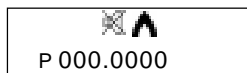

Priority Channel
deleted from scan
list



Group Number Channel Number

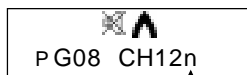

Narrow
Band

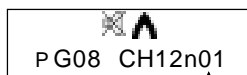

Reassigned Code
Guard Channel



- Priority channel/deleted channel specifier (first display character position)
 - P** = Group priority channel
Select in scanlist
 - p** = Group priority channel
Delete from scanlist
 - “ ”** = Not group priority channel
Select in scanlist
 - d** = Not group priority channel
Delete from scanlist
- Current Group Number
 - GXX** = display character position 2–4
 - XX** = group number 1 through 15
- Current Channel Number
 - CHYY** = display character position 6–9
 - YY** = channel number 1 through 16
- Channel Spacing
 - n** = narrow band
 - w** = wide band
- Variable Guard reassignment
 - ZZ** = display character position 13–14
 - ZZ** = reassigned Code Guard channel, between 1 and 16

For example, the display to the left shows group 8 is tuned to channel 12 (which happens to be the group’s priority channel, which is currently deleted from the scan list). The Code Guard has been reassigned to the Code Guard on channel 2, and the radio is tuned using wide band channel spacings.

SELECTIVE CALLING

Radio Paging Code

Your dealer can program your radio to decode 2-tone, 5-tone and DTMF ANIs, and encode 5-tone and DTMF ANIs.

Receiving a Call

With the radio in receive mode, the squelch will only open when it receives an ANI code that is identical to its own ANI code.

- 2-Tone Decoding

The Aurora radio is capable of receiving and decoding 2-tone-sequential paging. Your dealer can program the tone frequencies to cover Motorola 1+1, Reach Two Tone, and GE Type 99 formats. The dealer can also program tone duration and intervals down to a zero interval. The radio has the capability to decode *RELM All Call* on either Tone A or Tone B. The 2-tone page causes an audible warbling notification.

- ANI Decoding (Receive ANI)—DTMF or 5 Tone

The Aurora radio can have up to five separate ANI page codes (each up to 10 digits) that can be assigned to a channel's receive frequency for general paging.

The paging codes are:

- Unit ID
- Group ID
- All Call ID
- Stun ID
- Radio Check ID

When you receive a 2-tone, 5-tone (except radio check and stun) or DTMF ANI paging code, you can hear a warbling ring. This ring sounds the same for 2-tone and DTMF pages, but the group and all-call pages each have a different warbling ring. Your radio will ring for 3 seconds when you receive a call. (See Receiving a Call, page 56).

Sending a Call

The Aurora radio can encode the ANI paging code for the Unit ID of a channel group. The 5-tone or DTMF code is assigned to the transmit frequency of a channel. Your dealer can program your radio for either leading PTT, trailing PTT, or both edges of PTT when you transmit a call. These PTT options are programmed per channel for an internal time-out cycle. The ANI is not transmitted during the time-out period.

You can encode subaudible and audible selective call signals simultaneously, but the radio can only decode either subaudible or audible selective calling signals on the receive frequency of a channel.

If you are using an advanced Aurora radio, you can generate call page dialing/ANI sequences (DTMF or 5 Tone). These options can be used for selective paging of other radios. Advanced models can also access and transmit paging and dialing number sequences stored in the frequently called numbers list in your radio.

RADIO CHECK

The Aurora radio has a radio check feature that is active whenever your radio is:

- Programmed for receive-ANI paging
- Tuned to a channel that has receive-ANI assigned
- Placed in tone mode

When radio check is active, if your radio receives its radio check paging ANI, then it transmits with its unit ID paging ANI. If the transmit channel being transmitted is programmed for transmit ANI, then the unit ID goes out as specified by the transmit ANI protocol (DTMF or 5 Tone). If the transmit channel is not programmed for transmit ANI, the unit ID is sent out using the default paging parameter that was programmed by your dealer.

DTMF DIALING

Advanced Aurora radios can generate DTMF dialing sequences. To send DTMF tones, refer back to DTMF Encoding, page 36.)

Originating a Call

1. Key in a number (up to 10 digits).
2. If the channel is not busy, press **PTT** to automatically transmit the connect tone and ANI code of the radio.

REMINDER: The number does not have to be keyed in each time you make a call unless you want to change the number or the radio has been turned off since the last call.

3. Press the **PTT** switch to enable the transmitter and the DTMF keypad.
4. While holding in the **PTT** switch, either press the desired DTMF keys and/or speak into the microphone of the radio.
5. After you finish talking, release the PTT switch to listen to any reply.

Frequently Called Numbers and Call Paging

The Aurora radio can permanently store a list of 10 frequently called numbers (FCNs). Each number can have up to 10 digits. The FCN list can be for DTMF or 5-Tone dialing or paging code sequences.

You can also assign alpha labels (up to 10 characters each) to each FCN list number from the keypad. In addition, your radio also has separate memory to permanently store a sequence of quick-call page numbers and alpha labels of up to 10 characters.

When you transmit a call page or FCN sequence, the ID of your radio goes with it. This allows the Aurora radio that is receiving the call to identify and display who paged it.

Call page or FCN sequences are transmitted after you

1. Select the CALL feature or one of the FCNs from the function menu
2. Press the PTT switch

The page/FCN of your radio is transmitted on the appropriate channel depending on the manual/scan/priority mode of your radio and the carrier activity when you press the PTT switch. If the transmit channel has Transmit-ANI assigned, the leading/trailing/or both Transmit-ANIs are sent as normal. The radio uses either the DTMF or 5-Tone ANI assigned to the channel. The call page/FCN goes out after the leading ANI and before the trailing ANI. Independent of whether DTMF or 5-tone was assigned to the Transmit-ANI channel, the call page/FCN goes out using the DTMF or 5-Tone ANI you specified when defining the call page or FCN.

Note: Call pages/FCNs using DTMF digits “*” and “#” might yield unpredictable results when used within 5-Tone systems.

The Aurora radio can be factory enabled so you can access radio paging from the function menu. When enabled, the radio paging operation is able to transmit the FCN list of call pages.

RADIO PAGING



Channels with radio paging code signals are indicated in the display with the radio page icon [] regardless of whether channels, frequencies, or alphas are being displayed.

When the radio is receiving signals and the radio page icon is illuminated, the receive frequency has a paging code assigned. If the radio is in monitor mode, the radio page icon will not be illuminated while receiving.

When your radio is transmitting and the radio page icon is illuminated, the transmit frequency has a paging code assigned. This code will go out on the leading edge, trailing edge, or both edges of the PTT press.

FLEX MODE

The Aurora radio has two IF sections and operates on either 12.5 kHz (narrow bandwidth) or 30 kHz (wide bandwidth) for the VHF model radio. The operating bandwidth of the channel is a dealer-programmable option that you can select on a per-channel basis.

KEYPAD AND CHANNEL SELECTOR LOCK

You can lock the keypad on your radio so any presses on the keypad are ignored by the radio. While the keypad is locked, you can see the lock icon [] in the display.

To lock or unlock the keypad, press and hold [#] for 2 seconds.

BUSY CHANNEL LOCKOUT

The Aurora radio has a Busy Channel Lockout [BCL] feature that you can use to program individual channels. With the BCL feature, you can keep anyone from hearing a channel unless the correct Code Guard signal is received.

With BCL set, the transmitter cannot transmit until the channel is free of activity. If the channel is active, the transmitter cannot transmit until a correct decode Code Guard is received. If the BCL transmit criteria is not met, you will hear a boop. When this happens, release PTT and try transmitting again.

If the BCL feature is set for a channel and that channel has a Code Guard assigned to it, the carrier must have a tone. If a carrier is detected on that channel and no tone is present, then the radio will remain muted [no tone is the wrong tone].

The BCL feature is activated whenever you tune in to a channel that has BCL assigned. If BCL mode is set on the channel, the tone/monitor feature will not override the BCL function.

BATTERY POWER

Battery Saver



Low Battery Icon

The Aurora radio has a battery-saver feature that your dealer can program on a per radio basis. If enabled, the radio performs the battery-saver function when receiving channels without receive-ANIs whenever in manual mode and priority operation is turned off.

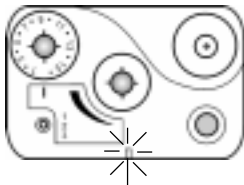

Low-battery indicator

The battery-saver function cycles the power to the RF, audio, and CPU hardware, temporarily powering down the hardware when the channel is not busy. The Aurora radio has three low-battery thresholds to let your radio run as long as possible before shutting down.

Low Battery

First Battery Threshold



The Aurora radio has a first battery threshold level, which causes the radio to transmit all channels using low power, regardless of the transmit power setting for that channel. You will see the low-battery display icon [] once the battery voltage of the radio goes below this threshold level.

At the first low-battery threshold, only the low-power transmit icon [] is lit regardless of the programmed transmit

power of the channel or the power setting you select. You will hear a low-battery audio beep once every 30 seconds.

Once the radio shows the low-battery icon, even if the battery voltage goes above the threshold setting, the radio will remain in the low-battery condition until you replace the battery.

Second Battery Threshold

The Aurora radio has a second battery threshold level. When the second battery threshold is reached the status LED will flash and the radio will not transmit until the battery is removed and reinstalled at a level above threshold two.

Third Battery Threshold

The Aurora radio has a third battery threshold level. When the third threshold is reached, the radio suspends all functions and in advanced models, “Low Battery” is displayed. Low-battery threshold three indicates the radio battery has discharged to a level at which you need to recharge the battery immediately to prevent battery damage.

Turn the on/off switch into the OFF position and charge the battery before using the radio again.

RADIO POWER-UP

The Aurora radio performs a power-up initialization and self test. The initialization includes loading fixed factory and computer-programmed settings, as well as the configurations and modes you entered into the radio before you turned it off. During the initialization, the firmware version number of the radio is written to the first four bytes of the e2prom. After you initialize the radio, the radio hardware is tested to make sure the synthesizer locks at the extremes of the radio's tuning range.

ERROR MESSAGES

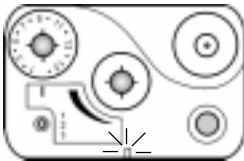

Orange status indicator



If the status indicator glows orange, your radio has made an error. Advanced model radios will also display “Error” with a number. The radio will then try to return to normal operation.

You can clear the error by changing the channel knob position during the 5 seconds the status indicator stays orange.

STUN

Your dealer can program your radio to have a stun feature. This feature lets a dispatcher disable normal radio functions in case the radio is lost or stolen.

The stun feature is active if the radio is:

- Factory-enabled for audible ANI paging
- Tuned to a channel that is assigned a receive ANI
- Placed in tone mode

When the stun feature is active and the current group's stun code is received, the radio transmits the unit ID of that channel. This mutes the radio audio and disables any further transmitting.

While a radio is stunned, if it receives the current group's stun code again, the radio will cancel the stun mode restrictions and return to normal radio operation.

AURORA PROGRAMMED SWITCH SETTINGS

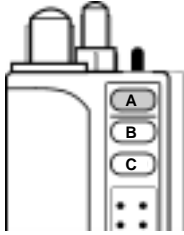

Side Switch Settings (Factory Setting)

Switch A _____ (Code Guard;
Tone/Monitor)

Switch B _____ (Priority)

Switch C _____ (Hi/Low Power)

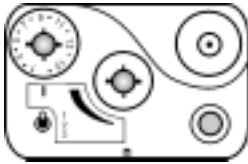

3-Position Toggle Switch

1 _____ (Channel Frequency)

2 _____ (Channel Label)

3 _____ (Group, Channel, BW)

Emergency Switch Setting

_____ (Scan)

Group Number _____ Group Label _____

Chan	Receive		Transmit		Label	Band
	Frequency	CG	Frequency	CG		
1	_____	_____	_____	_____	_____	_____
2	_____	_____	_____	_____	_____	_____
3	_____	_____	_____	_____	_____	_____
4	_____	_____	_____	_____	_____	_____
5	_____	_____	_____	_____	_____	_____
6	_____	_____	_____	_____	_____	_____
7	_____	_____	_____	_____	_____	_____
8	_____	_____	_____	_____	_____	_____
9	_____	_____	_____	_____	_____	_____
10	_____	_____	_____	_____	_____	_____
11	_____	_____	_____	_____	_____	_____
12	_____	_____	_____	_____	_____	_____
13	_____	_____	_____	_____	_____	_____
14	_____	_____	_____	_____	_____	_____
15	_____	_____	_____	_____	_____	_____
16	_____	_____	_____	_____	_____	_____

PROGRAMMED SETTINGS FOR YOUR RADIO

Group Number _____		Group Label _____				
Chan	Receive		Transmit		Label	Band
	Frequency	CG	Frequency	CG		
1	_____	_____	_____	_____	_____	_____
2	_____	_____	_____	_____	_____	_____
3	_____	_____	_____	_____	_____	_____
4	_____	_____	_____	_____	_____	_____
5	_____	_____	_____	_____	_____	_____
6	_____	_____	_____	_____	_____	_____
7	_____	_____	_____	_____	_____	_____
8	_____	_____	_____	_____	_____	_____
9	_____	_____	_____	_____	_____	_____
10	_____	_____	_____	_____	_____	_____
11	_____	_____	_____	_____	_____	_____
12	_____	_____	_____	_____	_____	_____
13	_____	_____	_____	_____	_____	_____
14	_____	_____	_____	_____	_____	_____
15	_____	_____	_____	_____	_____	_____
16	_____	_____	_____	_____	_____	_____

TROUBLESHOOTING GUIDE

NOTE: Please perform the simple checks indicated for improper operation before returning the radio for service.

TROUBLE	CHECK
No display, no sound	Turn PWR/VOL control clockwise. Charge or replace batteries.
Display OK, no sound	Turn volume control setting clockwise.
No reception (no stations heard)	Check antenna connection. Move to a location closer to a station. Enter correct frequencies.
Weak or poor reception	Turn squelch control fully clockwise and then counterclockwise until the “noise” just disappears. Move to a location closer to a station.
Does not scan	Turn the squelch control fully clockwise and then counterclockwise until Scan appears in the display. Check to see if channels are locked out.
Keypad buttons don’t work	Disable the keypad lock — See page 41.
Radio doesn’t operate very long	Charge batteries to full capacity for longer service life — See page 63.

NOTE: For in-warranty service information, contact your local dealer.

For future reference, please record:

Serial No. _____ Date Purchased _____

Dealer _____

MAINTENANCE

CAUTION: Do NOT tamper with the internal components. Damage to the equipment and/or improper operation could result.

Service

All adjustments affecting the transmitter power output, carrier frequency, or modulation **MUST** be performed by a qualified BK Radio electronics technician.

Have the radio checked periodically by a qualified BK Radio electronics technician.

For service, in or out of warranty, send radio to:

Customer Service Department

BK Radio

7505 Technology Drive

West Melbourne, FL 32904

1-800-648-0947, Fax: 1-321-953-7986

e-mail: www.bkservice@relm.com

NOTE: For in-warranty service information, contact your local dealer or BK Customer Service.

SPECIFICATIONS

(Subject to change without notice)

Aurora Radio

Number of Channels	16	240*
Frequency Range	136–174 MHz	
Operational Bandwidth	38 MHz	
Channel Spacing	25/30 or 12.5/15	
Channel Increments	2.5 kHz	
Size with battery; (W x D x H inches)	2.45 x 1.6 x 6.5	
Weight with battery and antenna	22.7 oz (0.64 kg)	
Power Requirements		
Battery Voltage	10V (9.6V)	
Current Drain		
Standby (w/ Battery Saver)	22 mA	
Standby (w/o Battery Saver)	56 mA	
Rated Audio	500 mW	
Transmit:		
1 Watt	0.8 Amp	
5 Watts	1.8 Amp	
Antenna Impedance	50 Ohms	
Speaker Impedance	32 Ohms	
Frequency Stability	± 3 ppm	
Operating Temperature	–30°C to +60°C (–22°F to +140°F)	

* *Advanced Model Radios Only*

SPECIFICATIONS (Cont.)

	25/30	12.5/15
Receiver		
Sensitivity (12 dB SINAD)	0.25 μ V	0.25 μ V
Operating Frequency Spread	38 MHz	38 MHz
Selectivity (Adjacent Channel)	-75 dB	-65 dB
Spurious including Image	-80 dB	-75 dB
Intermodulation	-75 dB	-70 dB
Hum and Noise Ratio	45 dB	45 dB
Audio Output @ 5% dist	500 mW	500 mW

Transmitter

RF Output Power	5/1 W	5/1 W
Spurious/Harmonics	-70 dBc	-70 dBc
Modulation	16K0F3E 16K0F9W	11K0F3E 11K0F9W
FM Hum and Noise	-46 dB	-40 dB
Audio Distortion	3%	3%
Audio Response (per TIA)	+1/-3 dB	+1/-3 dB

DEFINITIONS AND ACRONYMS

Alphanumeric	Both letters from the alphabet and numbers
ANI	Automatic Number Identification
BCL	Busy Channel Lockout
Beep	A higher tone of 1560 Hz
Boop	A lower tone of 780 Hz, “error tone”
BW	Band Width
CG	Code Guard
Cloning	The process of copying data from one radio, called “master,” to other radios, called “slaves” or “clones”
Code Guard	A subaudible tone for selective listening and receiving, sometimes referred to as tone code
Detent	The click/hesitation you feel as you turn a knob from one position to another
DTMF	Dual Tone Multiple Frequency
DTMF Tones	Tones that sound like those used by a standard push-button telephone
[E]nter	Enter
FCN	Function
[H]ome	Home
LCD	Liquid Crystal Display
LED	Light Emitting Diode
PRG	Program
PTT	Push To Talk
RTA	Repeater Talk Around
RX	Receive
SCN	Scan
Squelch	A control that eliminates background noise
Time-Out Timer	A feature that limits the duration of calls
TX	Transmit
VOX	Voice-Operated Transmission
Warble	Sound that quickly changes back and forth between beep and boop

NOTES



BK Radio
7505 Technology Drive
West Melbourne, FL 32904
(800) 648-0947
Fax: (321) 984-0434

© Copyright 2000 BK Radio. All rights reserved.

P/N 7001-30927-401

03-00